

DOT/FAA/AM-98/11

Office of Aviation Medicine
Washington, D.C. 20591

Evaluation of Improved Restraint Systems for Sport Parachutists

Van Gowdy
Richard DeWeese
Civil Aeromedical Institute
Federal Aviation Administration
Oklahoma City, OK 73125

March 1998

Final Report

This document is available to the public
through the National Technical Information
Service, Springfield, Virginia 22161.



U.S. Department
of Transportation
**Federal Aviation
Administration**

NOTICE

This document is disseminated under the sponsorship of the U.S. Department of Transportation in the interest of information exchange. The United States Government assumes no liability for the contents or use thereof.

1. Report No. DOT/FAA/AM-98/11		2. Government Accession No.		3. Recipient's Catalog No.	
4. Title and Subtitle An Evaluation of Pilot Acceptance of the Personal Minimums Training Program for Risk Management				5. Report Date March 1998	
				6. Performing Organization Code	
7. Author(s) Gowdy, R.V., and DeWeese, R.				8. Performing Organization Report No.	
9. Performing Organization Name and Address FAA Civil Aeromedical Institute P.O. Box 25082, Oklahoma City, OK 73125				10. Work Unit No. (TRAVIS)	
				11. Contract or Grant No.	
12. Sponsoring Agency name and Address Office of Aviation Medicine Federal Aviation Administration 800 Independence Ave., S.W. Washington, DC 20591				13. Type of Report and Period Covered	
				14. Sponsoring Agency Code	
15. Supplemental Notes					
16. Abstract <p>As part of a cooperative project between the Federal Aviation Administration's Civil Aeromedical Institute, the Parachute Industries Association, and the United States Parachute Association, a series of dynamic impact sled tests were performed to evaluate new types of restraint systems for sport parachutists. The traditional means of restraining sport parachutists sitting aft-facing on the floor has been to provide lap belts that are attached to the floor or sidewall of the airplane. The restraint systems evaluated in this project were designed to route through the parachute harness and attach to the floor. Thus, occupant restraint was provided by anchoring the parachute harness to the floor by means of the new restraint devices. Seven methods of attaching the restraints to the parachute harness, which included both single and dual point restraint systems, were dynamically tested. Five models of parachute pack/harnesses were included in this project. A VIP 50th percentile anthropomorphic test dummy was modified to simulate a floor-seated aft-facing parachutist. The impact test severity ranged from 5.5 gs @ 27.8 ft/sec to 9.5 gs @ 32.7 ft/sec.</p> <p>Based on the results and observations acquired from this series of 12, three of the new restraint methods demonstrated better restraint performance than could be expected from that provided by the traditional lap belt method currently recommended.</p>					
17. Key Words Sport Parachute Restraints			18. Distribution Statement Document is available to the public through the National Technical Information Service, Springfield, Virginia 22161		
19. Security Classif. (of this report) Unclassified		20. Security Classif. (of this page) Unclassified		21. No. of Pages 23	22. Price

EVALUATION OF IMPROVED RESTRAINT SYSTEMS FOR SPORT PARACHUTISTS



Typical Cabin Arrangement for Sport Parachute Operations
Figure 1.

Introduction

Sport parachuting continues to be a popular recreational and competitive activity. Recent data from the United States Parachuting Association (USPA) indicates that there are approximately 3,000,000 jumps per year at the 297 jump zones operated in the US. Membership in the USPA, which currently is over 33,000, has grown at a rate of 10% per year during the past few years (1). The emphasis on safety in every facet of sport parachuting operations has been the key factor in the increasing popularity and remarkable safety record of this aviation activity. Obviously, effective improvements in the equipment and procedures to enhance safety must be promoted by the parachuting community as well as the Federal Aviation Administration (FAA.)

One of the unique operational features of sport parachuting is the method for occupant restraint in an airplane. FAA regulations and guidance documents (2,3) allow parachutists to sit on the floor of the airplane with the passenger seats removed, as illustrated in Figure 1. The method of seating multiple

parachutists in an airplane is commonly referred to as the "caterpillar" arrangement. In this seating arrangement, the most forward passenger sits aft-facing on the floor with his/her back against a cabin wall. The other parachutists then sit between the legs of the person behind them in a single file stretching toward the aft end of the aircraft. This seating arrangement positions the parachutists to conveniently jump out the aft door. It also allows more passengers on board than could be accommodated in normal aircraft seats.

FAA regulations require that each parachutist must be restrained by a lap belt. Depending on the type of airplane, the attachment of the lap belts to the airplane will be to the floor or side wall of the cabin. For an aft facing parachutist seated on the floor, a lap belt routed over the anterior region of the pelvis does not provide a conspicuous means of restraining the parachutist during deceleration forces that could occur during emergency landing conditions. And, since there are no seat backs to restrain the parachutists from sliding toward the front of the airplane, the person seated

forward of each parachutist becomes the barrier for the combined forces and momentum of all the parachutists seated aft of his/her position in the airplane.

Accident investigation reports of recent sport parachuting airplane crashes indicate that aft-facing floor-seated parachutists in the "caterpillar" arrangement are not provided adequate restraint and protection from injury. Based on the results from these accident investigations, the National Transportation Safety Board (NTSB) issued safety recommendations to the FAA (4) concerning restraints for sport parachuting. One of the recommendations was that the USPA, in conjunction with the Parachute Industry Association (PIA) and the FAA's Civil Aeromedical Institute (CAMI), develop an improved means of protecting sport parachutists. In responding to this recommendation, the FAA initiated a project to develop an improved means of restraining a parachutist seated aft facing on the aircraft floor. This program was undertaken by the USPA, PIA, and CAMI.

USPA - PIA - FAA Parachutist Restraint Project

The participants in this project agreed to focus on improvements in restraints for parachutists in one of the most common cabin arrangements in airplanes used in sport parachuting. As noted above, the attachment of the lap belts to the airplanes used in sport parachuting operations is typically to the floor or side wall of the cabin. Many of these airplanes have seat tracks on the floor that run parallel to the longitudinal axis of the cabin. Depending on the size of the airplane, there may be one or two pairs of floor tracks normally used to anchor seats or provide anchor points for cargo restraints. These floortracks are designed to withstand significant structural loads, and in fact, are commonly used to anchor the lap belts in sport parachuting airplanes. Thus, one of the key considerations of this project was to utilize the existing structural attachments in the types of airplanes used for sport parachuting.

Another factor recognized and agreed upon by the project participants was the need to minimize the effects any proposed restraint methods might have on the normal activities involved in sport parachuting. These activities include boarding the airplane, restraint

adjustment by the parachutists, and release of the restraint in preparation for the jump. Also, the hardware and webbing for the improved restraint should not impede egress through the jump doors or emergency exits.

The level of safety that might be developed by an improved restraint method was not quantified during the initial discussions by the participants. It was agreed to investigate, by dynamic sled tests with an anthropomorphic test dummy (ATD), the performance of the proposed restraint hardware. The means of assessing the performance of the restraints would be primarily based on observations and measurements from the high speed films recorded during the tests. The test severity would be adjusted based on data and observations from the initial tests, starting with a pulse severity of approximately 6 gs.

Proposed Restraint Methods.

Participants from the USPA and PIA proposed the alternative methods for restraint of a floor seated parachutist. The proposed methods were based on an adjustable-length belt attached between the floor of the airplane and a point on the parachute harness by means of a quick release latch or buckle. The developers of this method postulated that if the parachutist positioned him/herself such that the proposed belt attachment to the parachute harness was forward (relative to the aircraft's orientation) of the floor anchor point for the belt, an improved method of occupant restraint would be achieved.

Floor-to-harness belt restraints with adjustment and anchor attachment hardware were provided as test specimens for this project. These restraints were fabricated with two inch wide webbing, a length adjustment mechanism, a floor track anchor at one end, and either a loop or a clip with a quick release on the other end for attaching to a portion of the parachute harness. The systems provided were rated at 1500 pounds and conformed to Technical Standards Order (TSO) -C22f. An example is shown in Figure 2. The restraint used were prototypes supplied by Hooker Custom Harnesses.

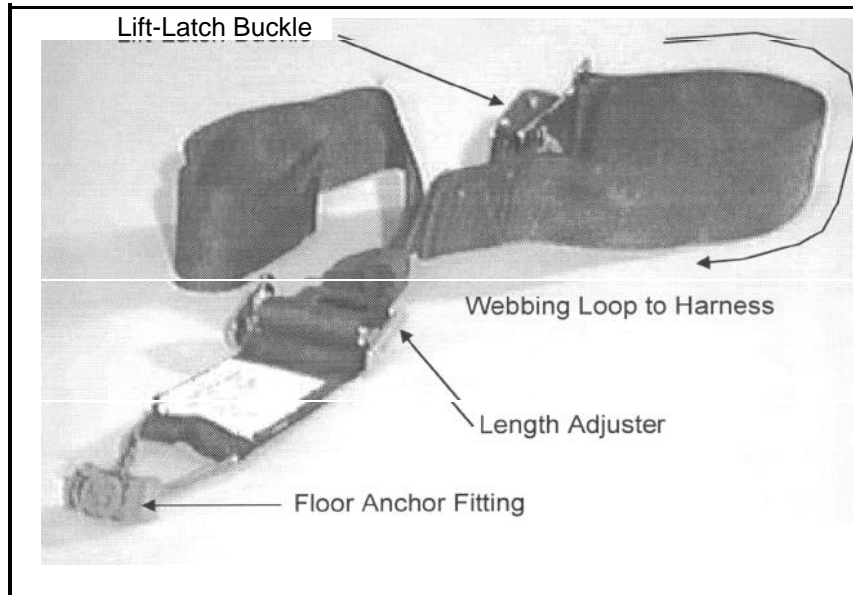

Figure 2. Floor-to-Harness Belt Restraint

Description of Tests.

Test Sled Setup. A series of 12 tests were conducted on CAMI's horizontal deceleration dynamic impact test track. The test sled was configured to represent the floor and side wall of a DHC-6 Twin Otter, which is a typical jump aircraft. Figure 3 shows a photograph of the sled setup, and Figure 4 shows the specific dimensions used for wall and seat track placement. The floor was covered with carpet typical of these aircraft. Restraint anchor locations used in this series are also identified by test number in Figure 4.

Modified ATD. The pelvis flesh of a 50th percentile male VIP-50 test dummy was modified to allow the legs to freely articulate between the upright seated position on the floor and lying flat. The VIP-50 is similar to the Hybrid II that is currently used for aircraft seat testing. The ATD was outfitted with typical sport parachutist gear consisting of a jump suit, helmet, goggles, and lightweight shoes. No instrumentation was installed in the ATD since overall kinematics, as observed from high speed videos and films, were the focus of the study.

Parachute Equipment. The parachutes and harnesses tested were of several makes and models considered to be representative of those currently used by sport parachutists. The straps that made up the parachute harness were routed over the body of the ATD in the same basic fashion, regardless of model. The names commonly used for various sections of a parachute harness are illustrated in Figures 5,6, and 7. Also identified in Figure 5 are the restraint attachment methods, labeled 1 through 7, which were evaluated in this test series.

Test Protocol. The test plan included dual belt restraints, i.e., belts attached to the same location symmetrically on the left and right side of the parachute harness, as well as single belt tests with only one belt attached to the harness. All of the tests were conducted with one ATD outfitted in a parachute harness. These single subject tests did not evaluate the combined effects of parachutists seated forward and aft of the test subject. The test protocol was designed to acquire information on the ability of the floor-to-harness belt systems to restrain a floor seated

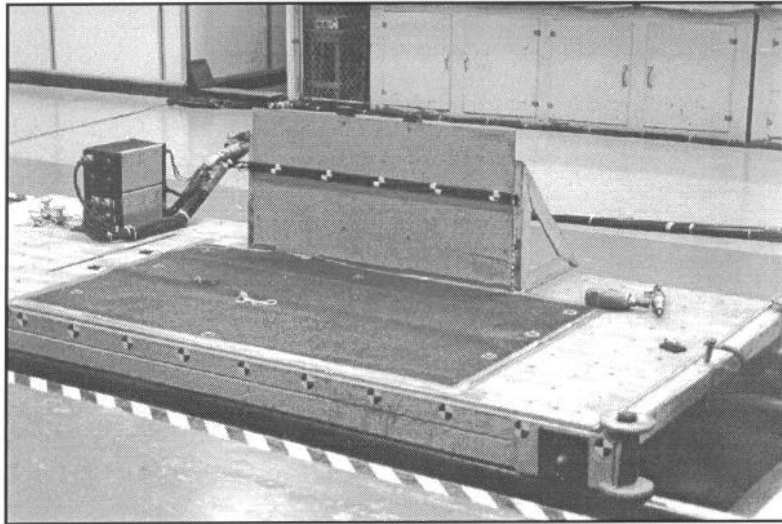
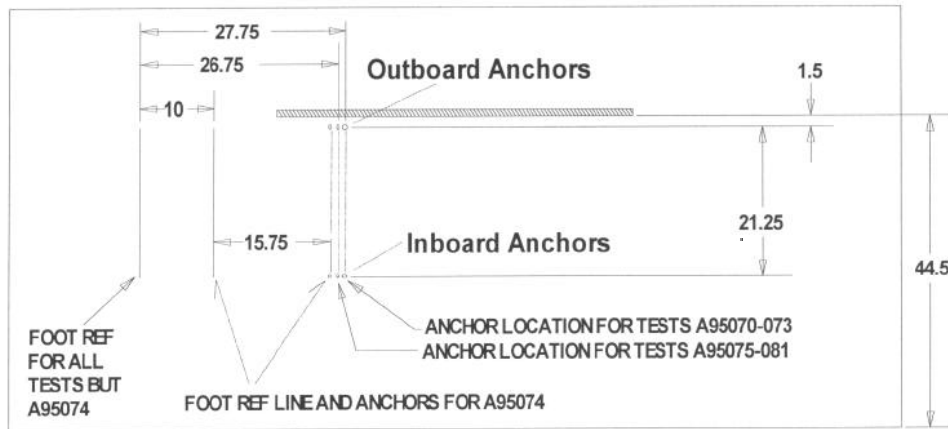
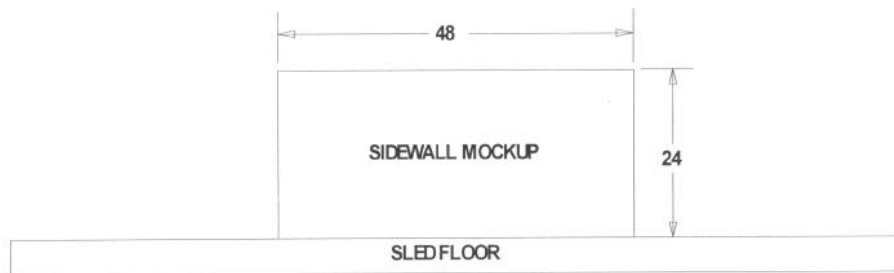

Figure 3. CAMI Test Sled Setup



SLED TOP VIEW



SLED SIDE VIEW

(DIMENSIONS IN INCHES)

Figure 4. Test Fixtures and Dimensions

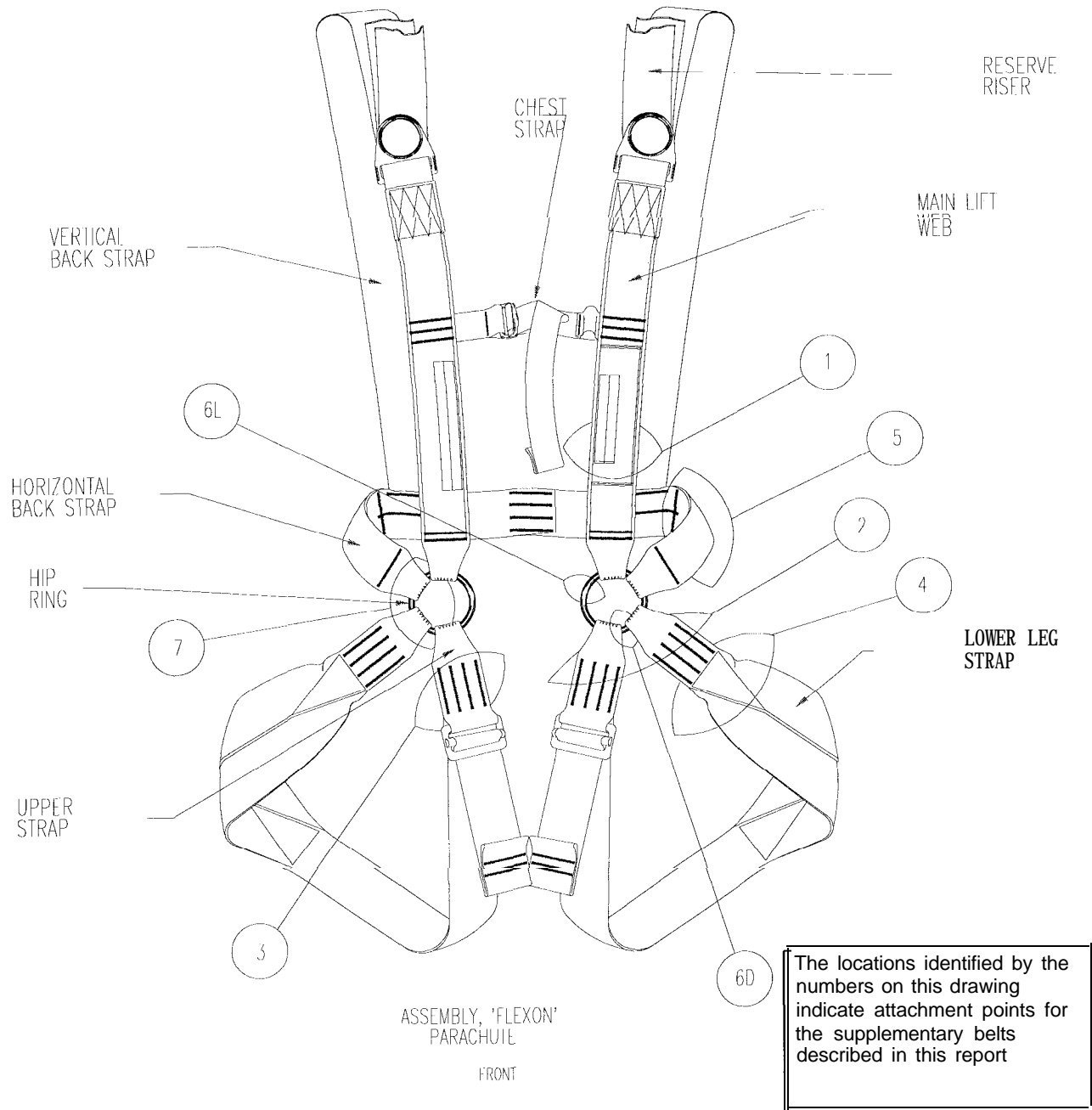

Typical Parachute Harness and Attachment Points for Floor-to-Harness Restraints
Figure 5.

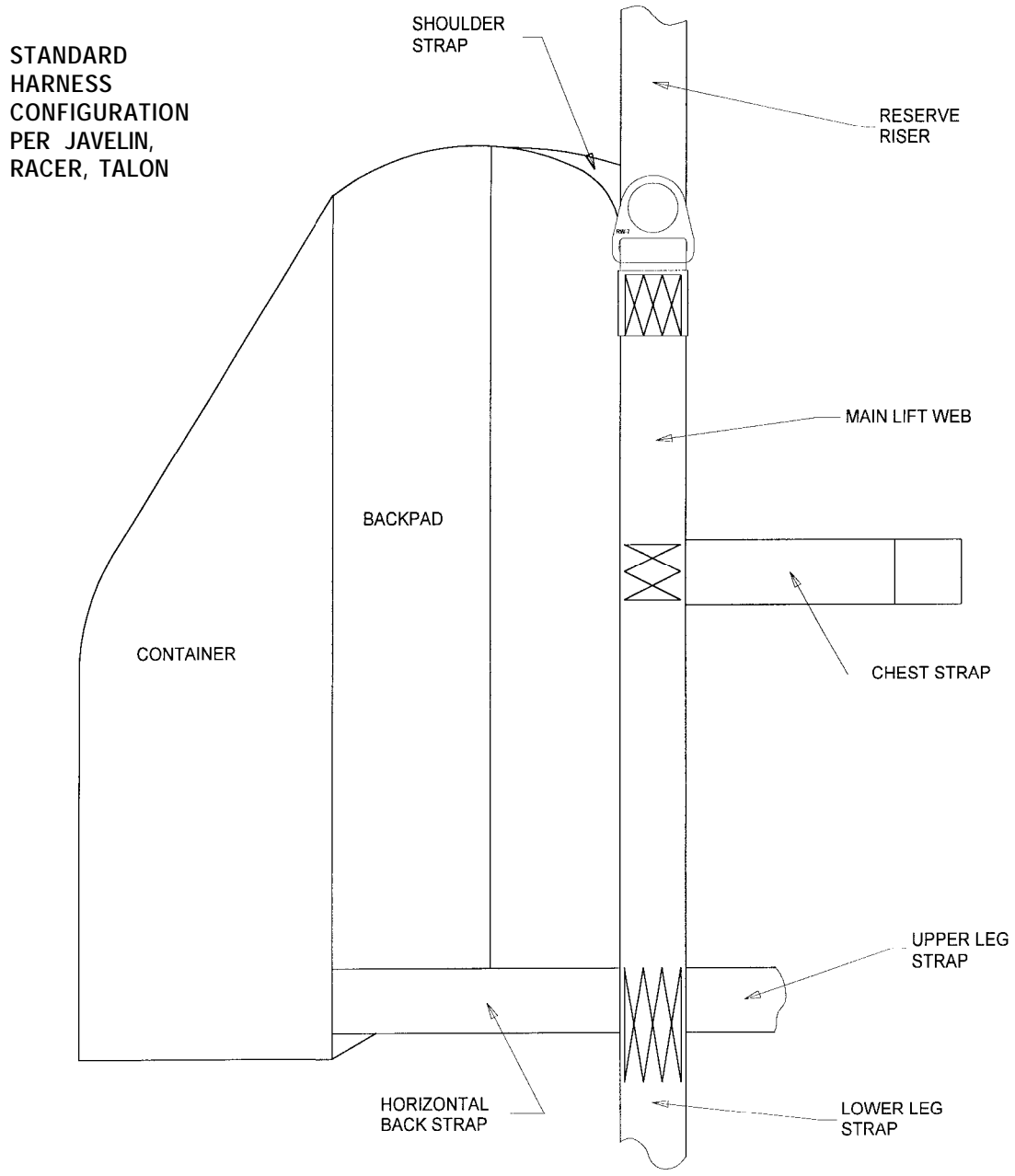

Figure 6. Standard Harness Configuration

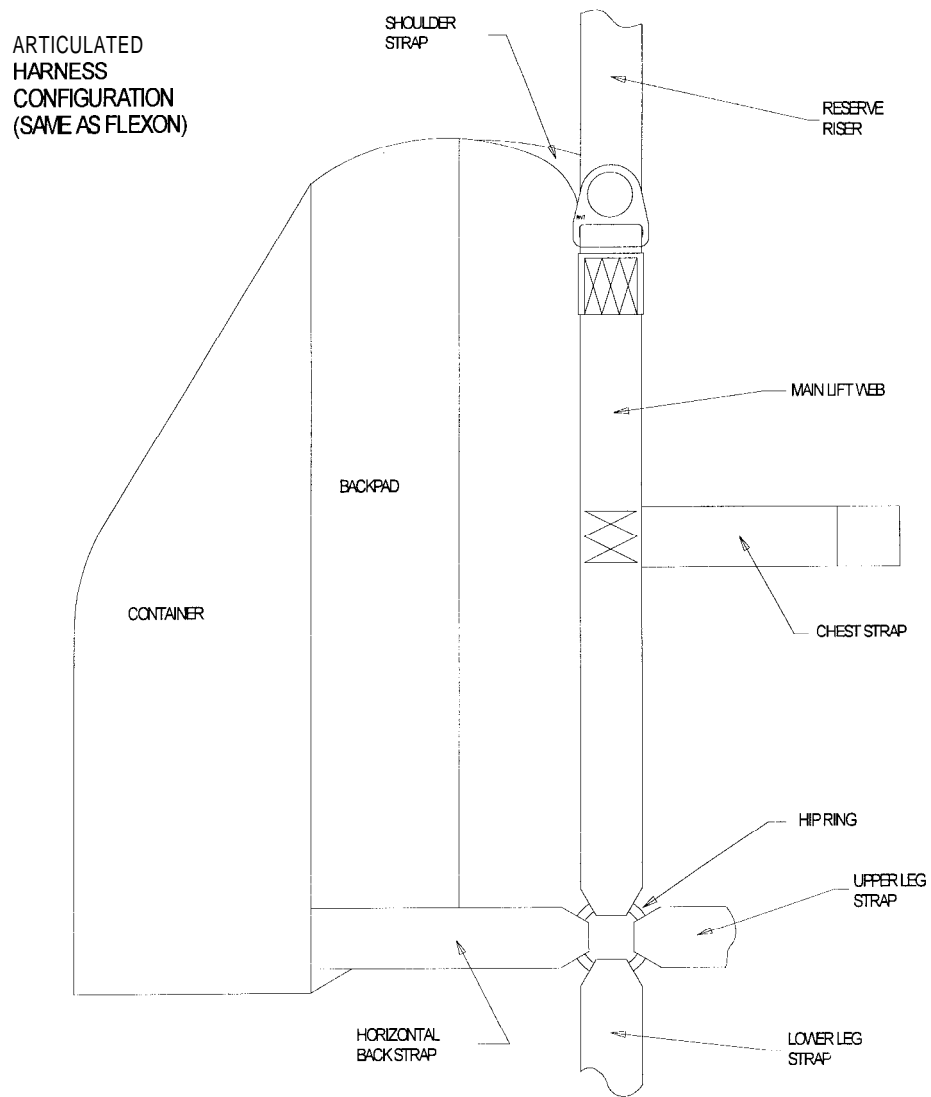

Figure 7. Articulated Harness Configuration

Test Number	Belts Attach Points *	Number of Belts	Parachute Equipment	Velocity (ft/sec)	Peak g's
A95070	1	Dual	Sunpath Inc. - Javelin	27.8	5.5
A95071	1	Dual	Sunpath Inc. - Javelin	27.9	5.5
A95072	1	Dual	Sunpath Inc. - Javelin	27.9	6.8
A95073	7	Dual	Jump Shack Inc. - Racer	27.6	6.7
A95074	4	Dual	Jump Shack Inc. - Racer	27.9	6.8
A95075	2	Single - Left	Rigging Innovations - Talon	27.6	6.8
A95076	5	Single - Left	Rigging Innovations - Talon	27.7	6.8
A95077	5	Single - Right	Rigging Innovations - Talon	27.8	6.7
A95078	6	Dual	Rigging Innovations - Flexon	27.9	6.8
A95079	6	Single - Left	Rigging Innovations - Flexon	27.8	6.7
A95080	5	Dual	Sunpath Inc. - Javelin	32.7	9.5
A95081	5	Dual	Strong Enterprises - Dual Hawk**	32.7	9.5

* Refer to Figure 5.

** Tandem harness only, used for training, no parachute pack

Table 1. Test Matrix

parachutist. The ATD was seated on the floor of the sled facing aft, with its right shoulder against the side wall mockup for all of the tests presented in this report.

Test Matrix. Table 1 is a summary of the matrix of tests conducted during this program. As shown in Table 1, eight of the tests were performed with dual belts attached symmetrically to the parachute harness,

and four tests were performed with only one belt. The single belt tests were designed to evaluate the proposed belt restraint in a simulated cabin interior with only one floor track available to attach the belt.

Note also the test severity ranged from 5.5 gs @ 27.8 ft/sec to 9.5 gs @ 32.7 ft/sec. The impact pulses approximated a trapezoidal shape, as shown in Figure 8. The rationale for this range of test severity was based

on the traditional static load requirements for seats and restraints in airplanes: 6 g limit and 9 g ultimate static loads. Although the association of static loads and dynamic responses is subject to misinterpretation, this range of dynamic test severity was selected because of the historical regulatory significance of the 6 g and 9 g static load airworthiness requirements for the types of airplanes used in sport parachuting.

Test Results and Summaries.

The following summaries describe the setup, restraint variation, and results noted from each of the tests. Refer to Figure 5 and Table 1 for additional details of the tests described below. The restraint methods described in the following summaries are identified by the attachment point shown in Figure 5, and the number of belts. For example, method “1D”

indicates *dual* restraints were attached near the lower end of the left and right main lift webs of the parachute harness, denoted as *point 1* on Figure 5. Likewise, method “2L” refers to a single restraint belt attached to the *left* side leg straps near the hip ring on the harness, denoted as *point 2* in Figure 5.

Restraint Method 1D: Restraint Looped through Main Lift Web, Left and Right

Three tests were conducted with proposed restraint method 1D as illustrated in Figures 9 and 10. In the first two tests, A95070 - 071, the ATD’s upper body leaned forward (relative to its body orientation) during the acceleration phase of the test prior to impact. Light cotton string was wrapped around the torso of the ATD to inhibit the upper torso from rotating, but the string broke prior to impact on both tests. The ATD

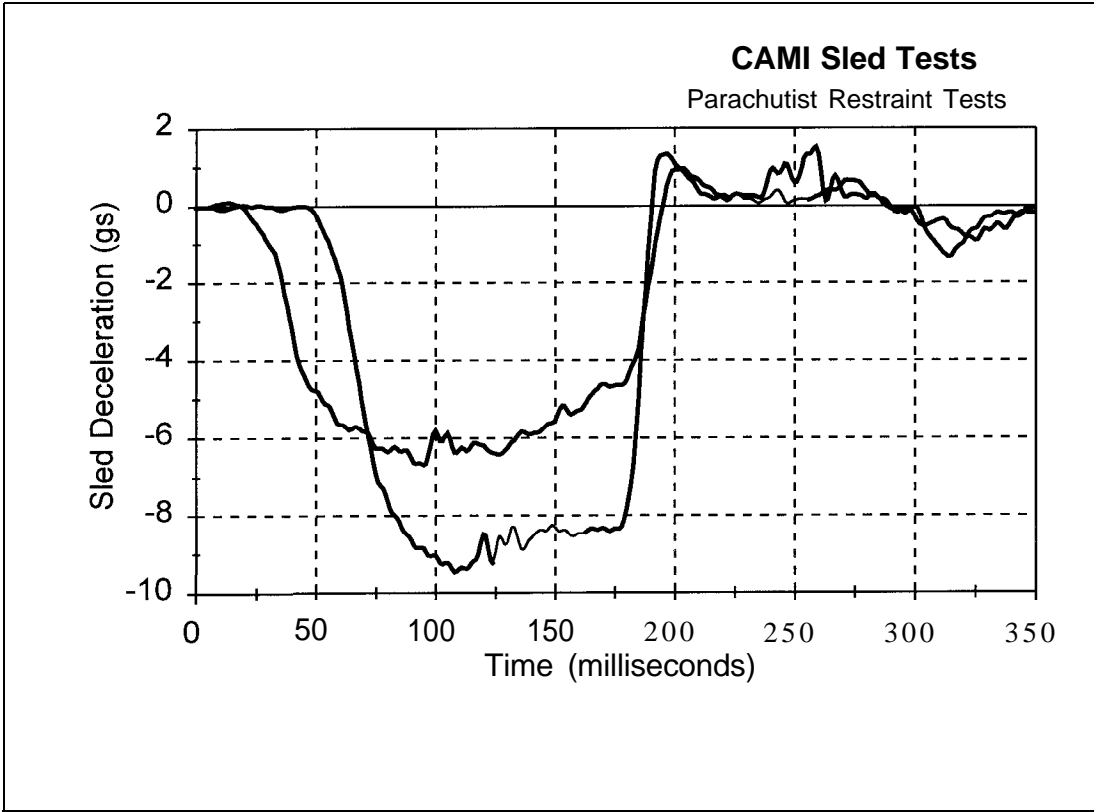

Examples of the 2 Impact Deceleration Pulses in the Project
Figure 8.

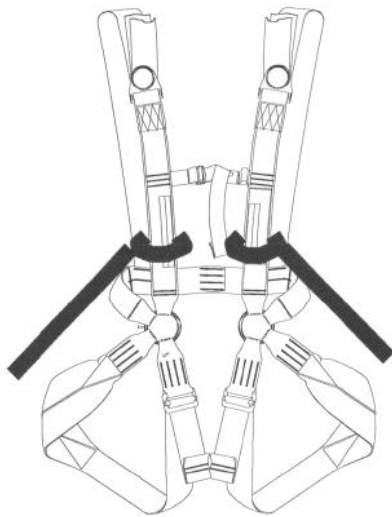

Restraint Method 1 D: Restraint Looped through Main Lift Web, Left and Right

Figure 9. Restraint Method ID

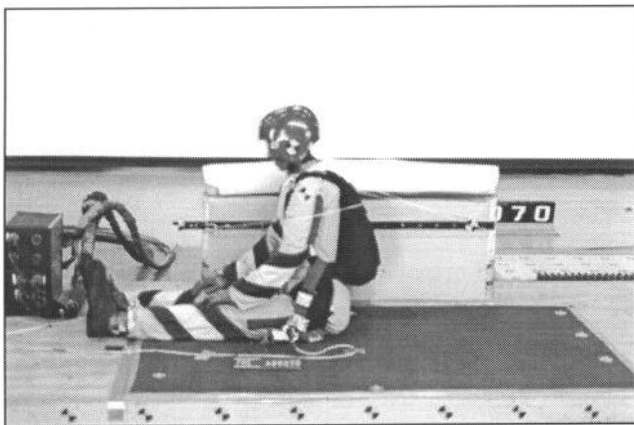

Figure 10. Pre-Test A95070

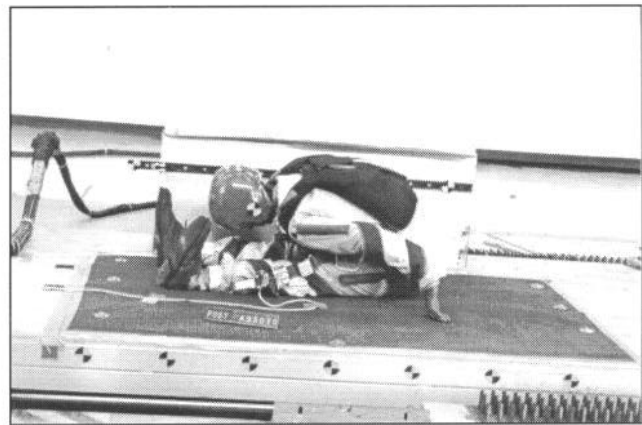

Figure 11. Post-Test A95070

was not in the desired sitting position at the start of the impact pulse. However, there was no gross flailing or excessive translation of the ATD in spite of the out-of-position posture. Figure 11 shows the post-test position of the ATD after the first test.

A stronger cord was used to support the ATD for the third test, A95072, as shown in Figure 12. The ATD remained in an upright seated posture up to the start of the impact pulse. An

examination of the high speed films from this test showed the ATD slid forward until the restraints attached between the main lift webs and the floor became taut. The ATD's upper torso rotation was arrested at approximately 25° from vertical. Figure 13 shows the post-test position of the ATD from test A95072. There was no headcontact with the floor.

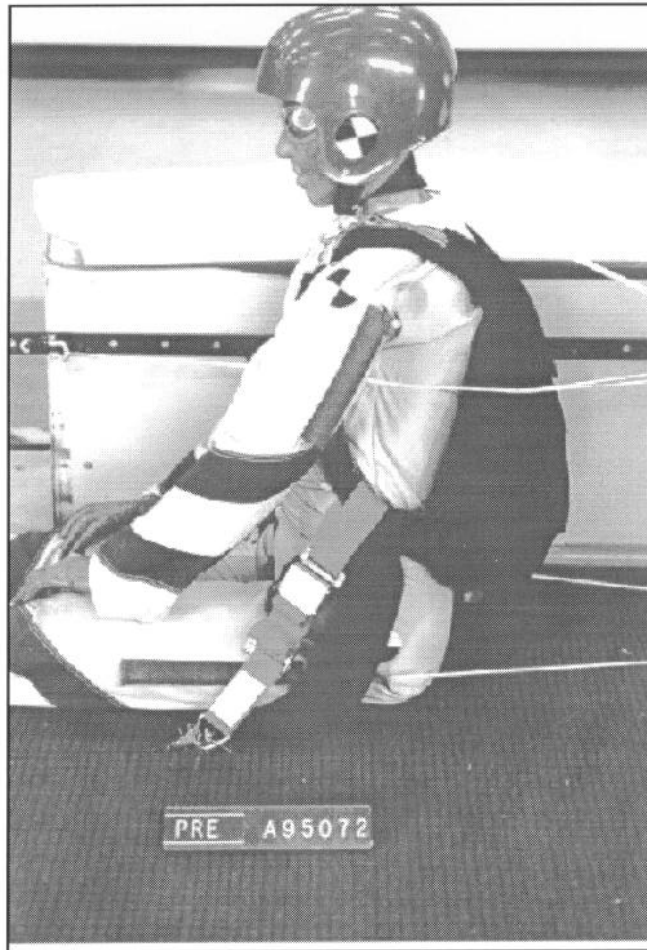

Figure 12. Pre-Test A95072

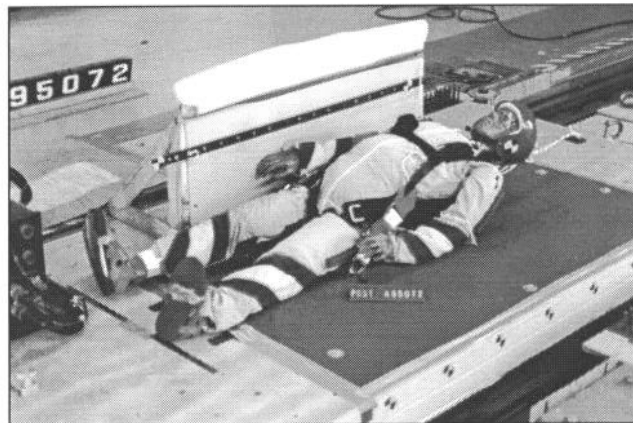

Figure 13. Post-Test A95072

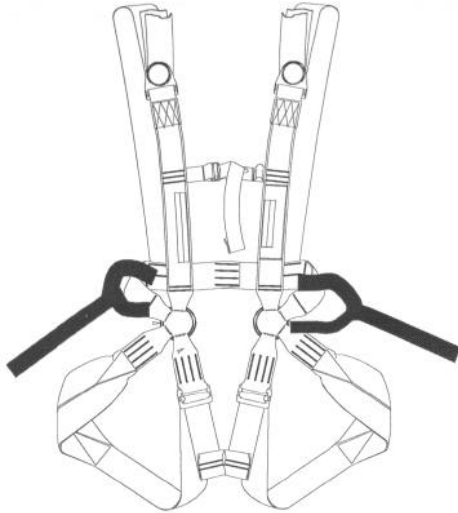

Figure 14. Restraint Method 7D

Restraint Method 7D: Restraint Looped through Horizontal Back Strap and Lower Leg Strap, Aft of Main Lift Web Junction, Left and Right

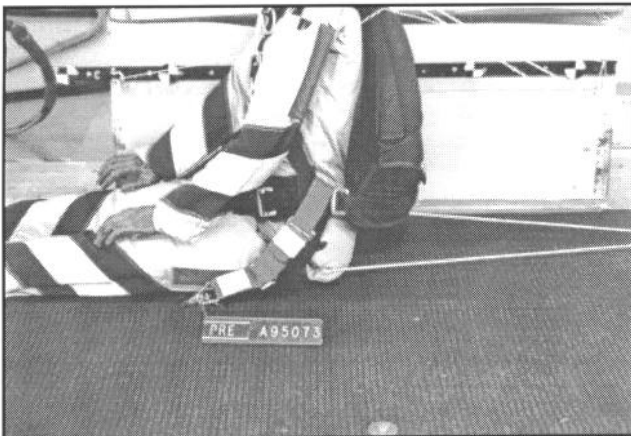

Figure 15. Pre-Test A95073

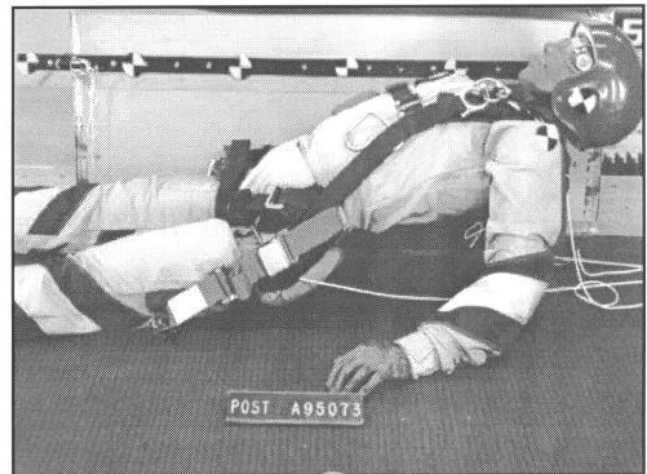

Figure 16. Post Test A95073

Test number A95073 evaluated attachment method 7D. As shown in Figures 14 and 15, this restraint consisted of a strap anchored to the floor on either side of the ATD and looped around the horizontal back strap and the lower leg strap just behind their intersection with the main lift web, on each side of the harness. The restraints were adjusted to their minimum length but were still slack. The ATD was placed in the same pre-test posture and held in place with cord as described above for test A95072.

During the impact, the ATD's entire body slid forward and its upper torso rotated forward in a similar manner to that noted from the previous test, A95072. In this test, however, the torso rotated further, to approximately 50° from vertical. Less neck extension was observed when compared to the films from A95072. The reduced neck extension was most likely due to the lower harness attachment point. The post-test position of the ATD is shown in Figure 16.

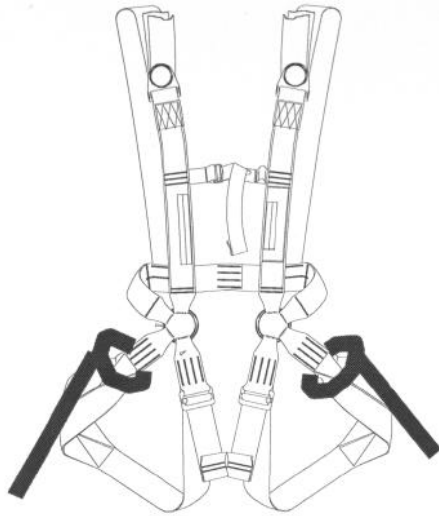

Figure 17. Restraint Method 4D.

Restraint Method 4D: Restraint Looped Around Lower Leg Straps, Left and Right.

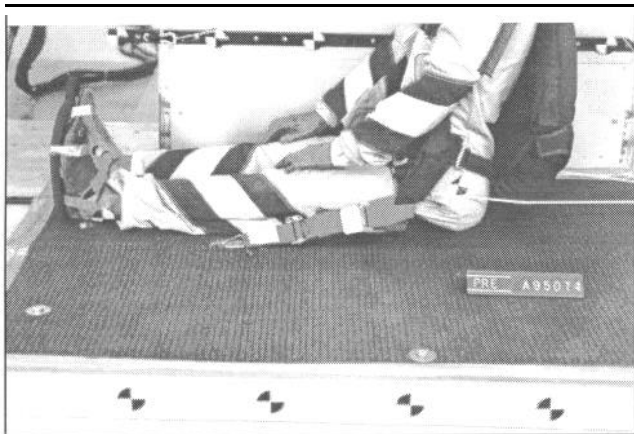

Figure 18. Pre-Test A95074

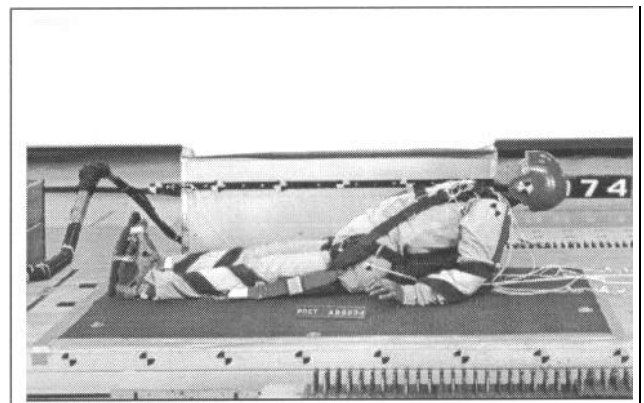

Figure 19. Post Test A95074

As illustrated in Figures 17 and 18, test A95074 evaluated attachment method 4D, which consisted of two straps anchored to the floor on either side of the ATD and looped around the lower leg straps on each side of the harness. Because of the lower harness attachment point, it was necessary to change the ATD's position relative to the restraint's floor attachment points. This was done to remove excessive slack from the restraints, while keeping them at the same length adjustment as in previous tests. The initial position of the ATD upper torso was also changed to a leaning back position (approximately 15 degrees to vertical) to better represent the actual parachutist position during takeoff.

The post-test review of the films from A95074 showed the ATD slid forward much less than noted on the previous tests. However, the forward rotation (e.g., leaning back toward the front of the airplane) of the upper torso was more pronounced, and the rotation was not stopped until the parachute pack contacted the floor. The maximum rotation of the upper torso was approximately 75° from vertical. Head contact on the floor was noted from the films. The rapid rotation was due to poor upper torso restraint afforded by the low harness attachment point. Figure 19 is a post-test photo from A95074.

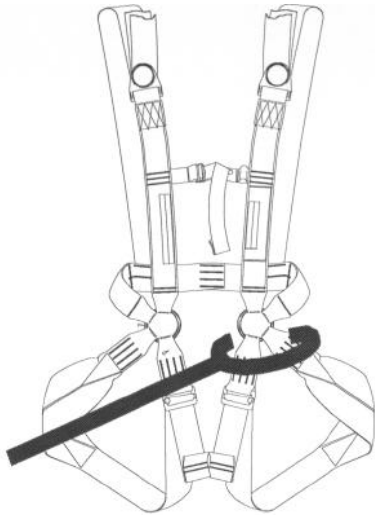

Figure 20. Restraint Method 2L.

Restraint Method 2L: Restraint Looped Around Upper and Lower Leg Straps.



Figure 21. Pre-Test A95075.

As shown in Figures 20 and 21, test A95075 was conducted with proposed restraint method 2L, which was comprised of a loop around the upper and lower leg straps just below their intersection with the main lift web on the left side of the harness. The initial position of the ATD was slightly leaning back as described for test A95074



Figure 22. Post-Test A95075.

The ATD slid forward significantly during the impact test. Then the restraint strap slid down on the parachute harness. Although the ATD legs remained aligned fore and aft, the pelvis and lower spine rotated clockwise (from above). The upper torso rotated about 60° from vertical and onto the parachute pack, producing notable neck extension. No head strike was observed on the test films. The post-test position of the ATD is shown in Figure 22.

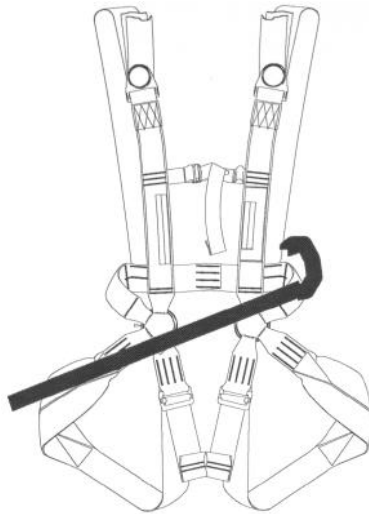

Figure 23. Restraint Method 5L

Restraint Method 5L: Restraint Looped Around Backstrap on Left Side of Harness.

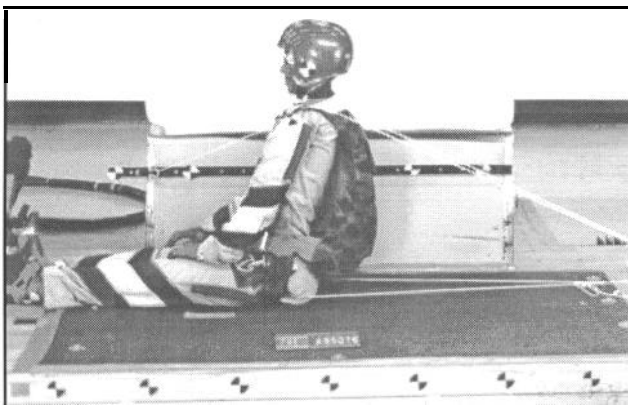

Figure 24. Pre-Test A95076.

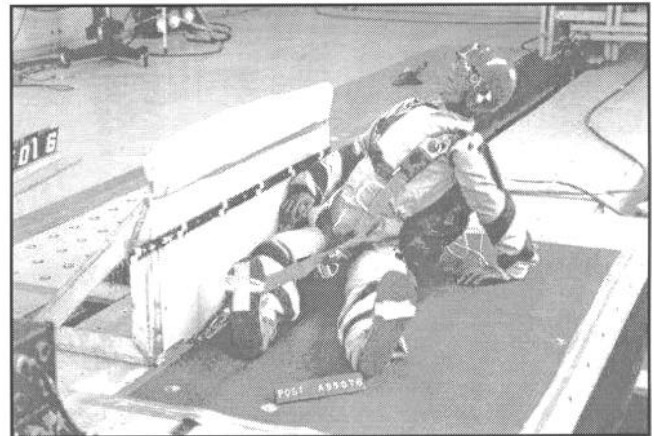
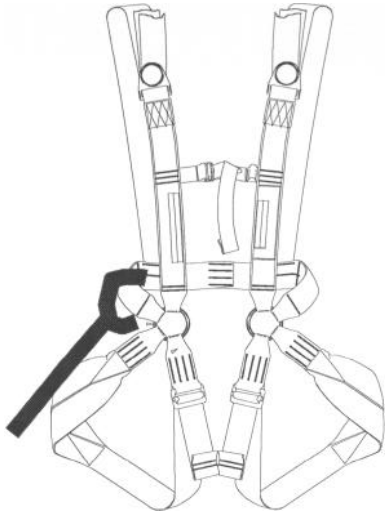

Figure 25. Post-Test A95076.

Test A95076 evaluated attachment method 5L which consisted of a single strap anchored to the floor near the side wall mockup routed up and over the lap of the ATD and looped around the back strap on the left side of the harness. Figures 23 and 24 illustrate this method. It was hoped this position would preclude the slipping seen in the previous test. The ATD positioning was the same as the previous test.

The overall kinematic motion of the ATD during this test was similar to A95075. During the test, the parachute harness web tore loose from the pack and rotated around the body about four inches, worsening the overall forward translation and clockwise rotation of the ATD in the horizontal plane. Figure 25 shows the post-test position of the ATD.



Restraint Method 5R: Restraint Looped Around Backstrap on Right Side of Harness.

Figure 26. Restraint Method 5R.

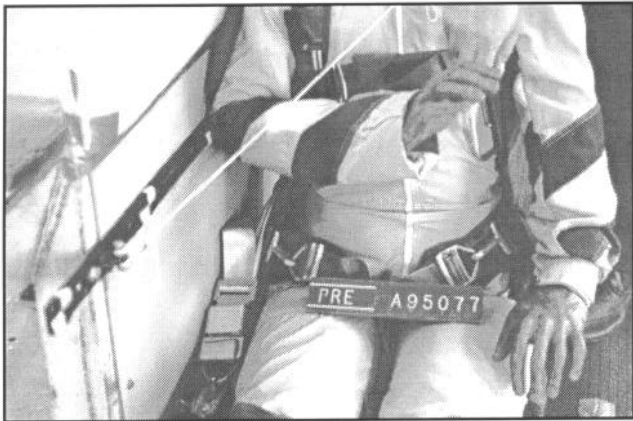

Figure 27. Pre-Test A95077.



Figure 28. Post-Test A95077.

Test A95097, illustrated in Figures 26, 27, and 28, evaluated attachment method 5R, which consisted of a short single strap anchored to the floor near the side wall mockup and looped around the back strap on the right side of the harness. Figure 27 shows the restraint between the ATD and the wall fixture. The ATD positioning was the same as the previous test. During

the impact, the ATD slid forward significantly, then violently rotated counter clockwise about the center of the pelvis. The upper torso rotated forward to 40 degrees from vertical and the legs flailed about the vertical axis to a position 90 degrees from initial. Figure 28 shows the final position of the ATD after this test.

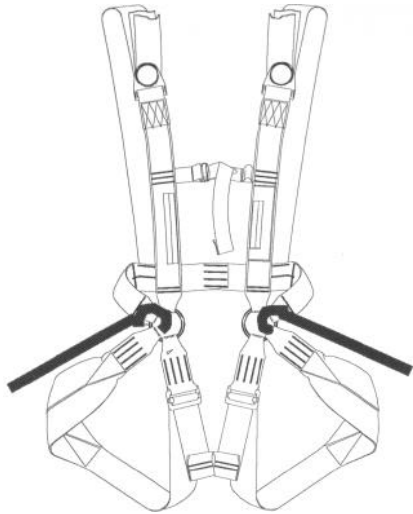

Restraint Method 6D: Restraints Attached to Metal Ring at Webbing Junction, Left and Right Side

Figure 29. Restraint Method 6D.

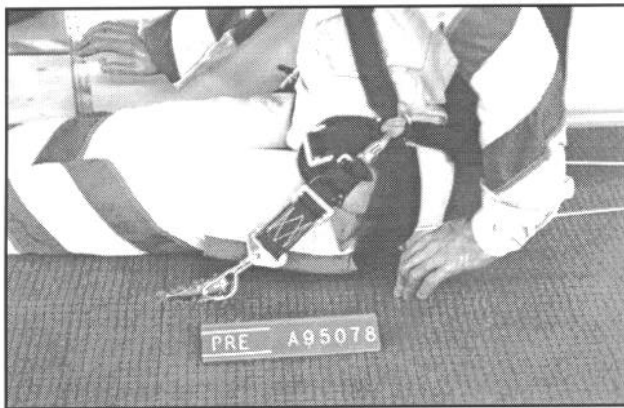

Figure 30. Pre-Test A95078.

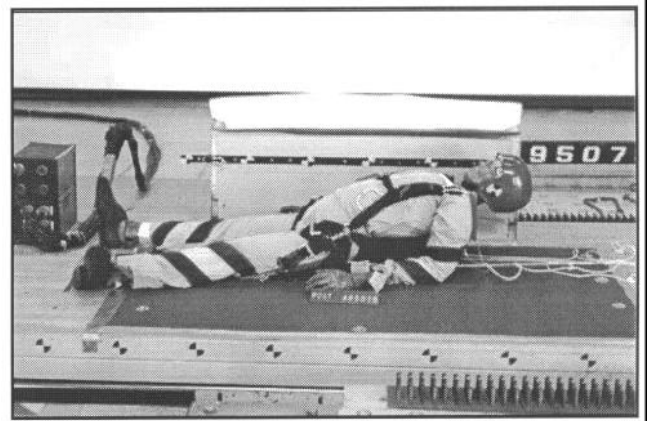
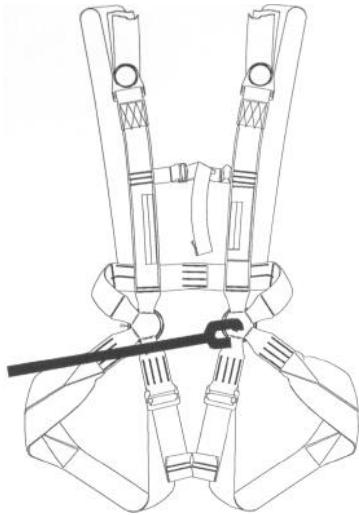

Figure 31. Post-Test A95078.

Test A95078 was performed with restraint attachment method 6D. This method consisted of two short straps anchored to the floor, on either side of the ATD, attached with clips to a circular metal ring incorporated into the harness of this particular model of parachute. This parachute, a Rigging Innovations Flexon, uses a metal ring to join the major straps of the harness at each side as shown in Figures 5, 29, and 30. The ring is located at approximately the same point as the intersection of the straps of the conventional harness. The restraint was clipped to the ring between the upper and

lower leg strap terminations. There was no slack in the restraints and the ATD positioning was in the partial “lean back” posture.

During this test, the ATD slid forward, then rotated over completely onto the parachute pack producing a moderate head extension but no head strike. Forward excursion of the pelvis was much less than with the single strap configurations. The ATD’s legs did not flail outward. The post-test position of the ATD is shown in Figure 31.



Restraint Method 6L: Restraint Attached to Metal Ring at Webbing Junction, Left

Figure 32. Restraint Method 6L

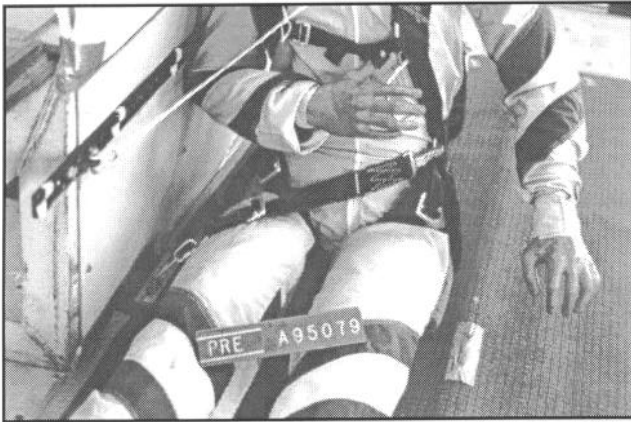

Figure 33. Pre-Test A95079



Figure 34. Post-Test A95079

Test A95079 evaluated attachment method 6L. Method 6L, illustrated in Figure 32, consisted of a single strap anchored to the floor near the side wall mockup, routed up and over the lap of the ATD and clipped to the left side hip ring of the Rigging Innovations Flexon parachute harness. The restraint was clipped to the ring between the main lift web and the upper leg strap terminations. There was no slack in the restraints and the ATD positioning was the same as the previous test. Figure 33 shows the pre-test position of the restraint over the pelvis of the ATD.

During the impact, the ATD slid forward as the harness rotated around the torso of the ATD in a similar manner to that noted in test A95076. The ATD legs remained fore and aft and the hips swiveled clockwise (from above). The upper torso rotated forward onto the parachute pack producing neck extension but no head strike. Figure 34 is a post-test photo. The overall kinematics were similar to test A95076.

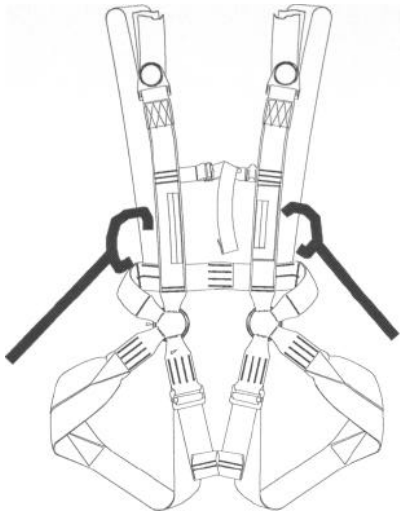

Figure 35. Restraint Method 5D.

Restraint Method 5D: Restraints Looped Around Horizontal Backstraps, Left and Right.

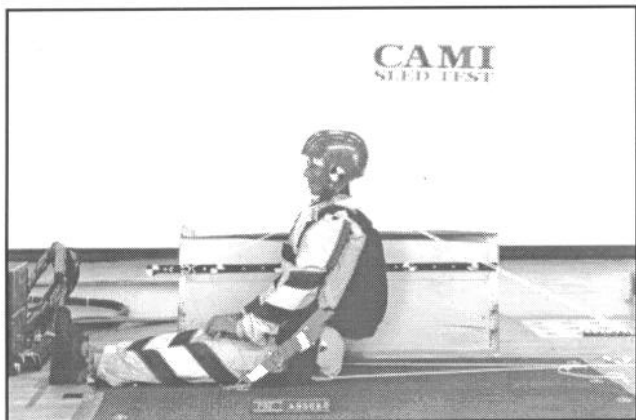

Figure 36. Pre-Test A95080.

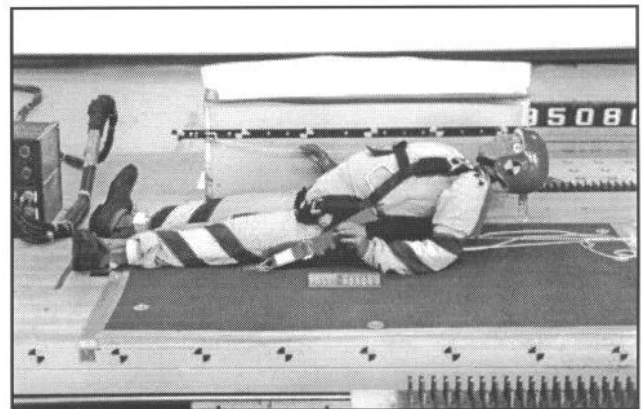

Figure 37. Post-Test A95080.

Test A95080, as illustrated in Figures 35 and 36, evaluated attachment method 5D, which consisted of two straps anchored to the floor on either side of the ATD and looping around the backstrap of the harness. The Sunpath Javelin parachute was used for this test. There was no slack in the restraints and the pre-test position of the ATD was in the “lean back” posture, as in the previous test. Confidence in the restraint method’s ability to adequately restrain the occupant led to a decision to increase the impact severity to 9 Gs. During the impact, the films showed the ATD slid forward and the upper torso rotated completely for-

ward onto the parachute pack. Moderate neck extension and head impact were noted on the films. The legs did not flail sideward, as shown in Figure 37.

An additional test, A95081, was conducted with proposed restraint method 5D, except the parachute harness installed on the ATD was a tandem passenger harness assembly. (The tandem harness is used for training.) Figures 38 and 39 show pre and post photos of this tests. The passenger harness has the same basic strap configuration as a normal parachute harness, but without the parachute or its container. This harness is made to be attached to the front of an instructor who

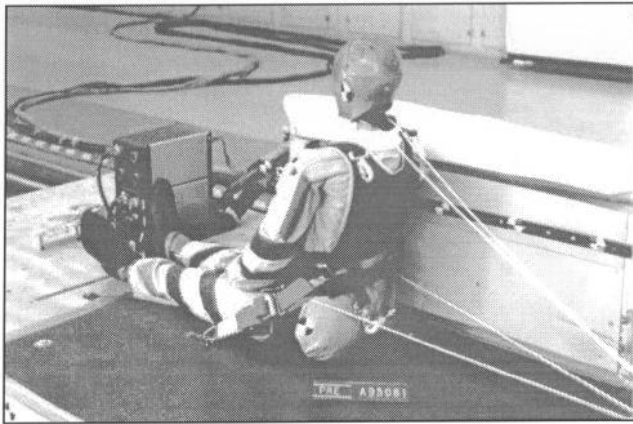

Figure 38. Pre-Test A95081.

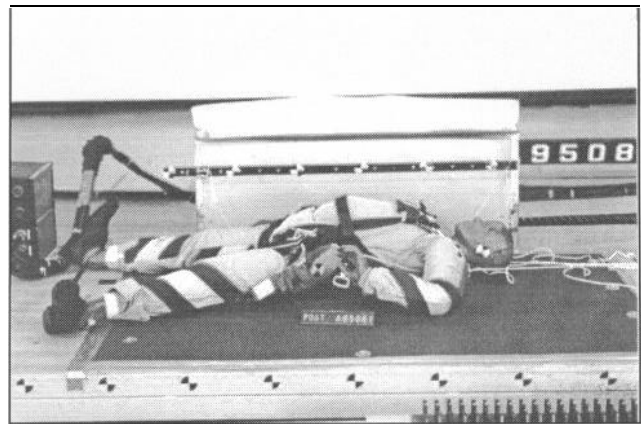

Figure 39. Post-Test A95081.

carries a parachute adequate for both of them. There was no slack in the restraints and the ATD positioning was the same as the previous test.

The ATD slid forward during the impact, and the upper torso rotated forward onto the sled floor. A head strike on the floor plane was noted in the films. The geometry of this tandem harness caused the pelvis to remain upright during the test, causing obvious bending of the spine during the upper torsos flailing. This tendency for the pelvis to remain upright, which was exhibited to some degree on all of the tests, may be an artifact of the ATD's pelvic construction, which is flat on the bottom.

Observations and Conclusions

Of the various methods evaluated in this project, methods 5D, 6D, and 7D appears to provide better restraint of the ATD under the test conditions described in this report. These methods produced the least flailing and bending of the body segments and the least forward translation of the pelvis. The single strap over the lap methods, 5L and 6L, while desirable due to their simplicity of use, did not provide the level of restraint offered by the dual strap methods.

The TSO-C22f, 1500 pound rated, prototype restraints used for this series appeared adequate for use in all of the methods evaluated. The same belts were used on repeated tests, and no visible signs of wear or damage were noted. Also, other than the one harness to container separation that occurred on test A95076, there was no damage or wear noted on the parachute

harnesses, which were also subjected to repeated tests. There does not appear to be a requirement for additional maintenance or inspection procedures for the harness, if used with these restraint methods, other than the current routine procedures practiced by the parachuting community.

Although not directly addressed by this test series, the potential for head and neck injuries may be minimized for each of these methods by the limited flail distance inherent to the "caterpillar" seating arrangement. Thus, restraining the parachutist by the means demonstrated in these tests appears to provide an obvious improvement in safety, when compared with the documented accident scenarios with the customary lap belt restraints unattached to the parachute harness.

The 5D method of restraint attachment appears to be the best candidate for operational implementation, among the ones tested. Routing of the restraint belt through the parachute harness is straightforward with this method, and it should work well on virtually any normal parachute. The 6D method of restraint attachment, which clips onto a ring sewn into the harness, has the advantage of being very simple and quick to use. However, implementation of method 6D would necessitate all parachutes not already incorporating a ring be modified to add a load bearing ring attachment at the intersection of the backstrap and main lift web. Although modifying parachutes to add the ring would obviously entail some time and expense, it may prove to be worthwhile, since this method minimizes the possibility of misuse. It may also enhance egress.

Some additional operational procedures that may improve the effectiveness of the methods described in this project include:

- a) The person most forward in the cabin should be leaning against a bulkhead or other substantial support to limit flailing and head impact.
- b) Each parachutist's restraint should be anchored to the floor aft of his/her pelvis (relative the aircraft's orientation) at a point on the floor near the middle of the thigh. The restraint should be taut to reduce forward motion and the loads transmitted to the person behind.
- c) The proper brace for impact position would be to lean toward the front of the aircraft onto the person or bulkhead behind them.

REFERENCES

1. Needels. C.. USPA's Executive Director's column, "Capital Commentary", *Parachutist* magazine, January 1997, p. 5.
2. Title 14, US Code of Federal Regulations, Part 14, Section 91.107. US Government Printing Office, Washington, DC.
3. FAA Advisory Circular AC105-2C, "Sport Parachuting", Flight Standards Service, FAA Headquarters, Washington, January 1991.
4. National Transportation Safety Board, Safety Recommendation No. A-94-017, issued by the NTSB to the FAA, May 1994.